

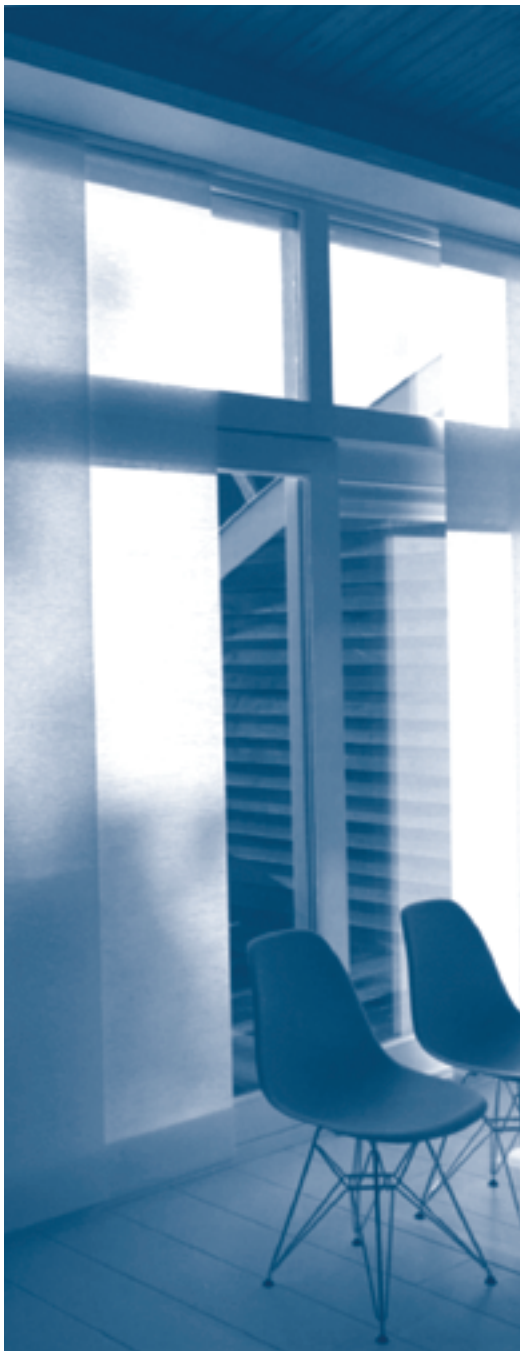

JAPONÊS

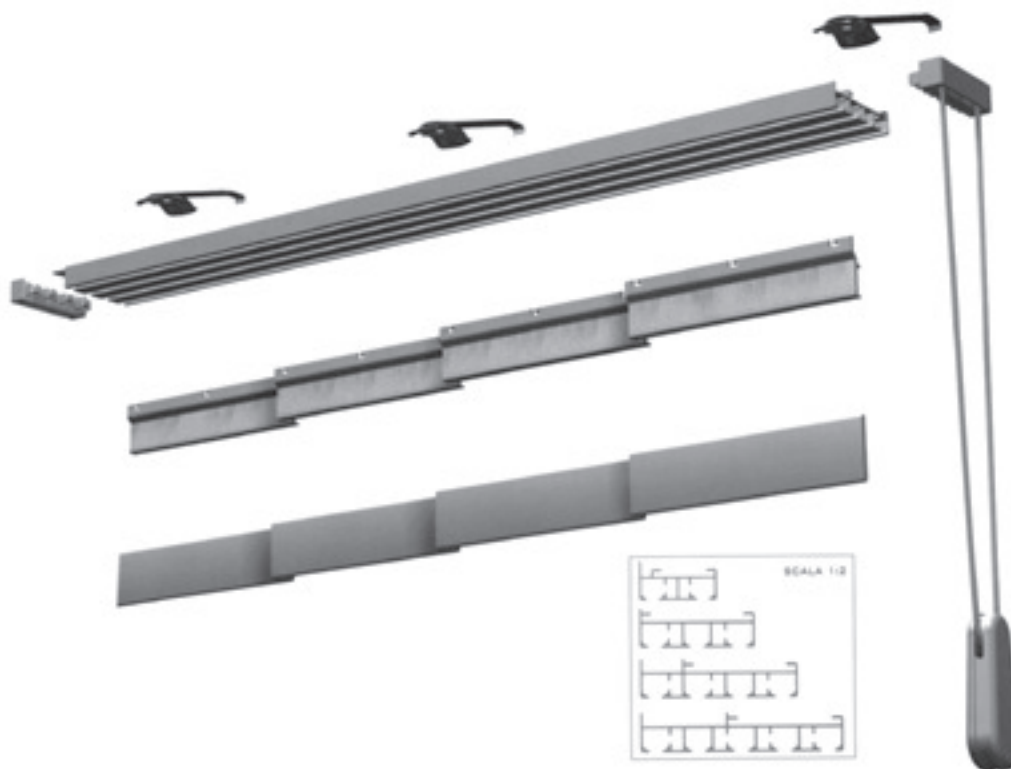

PAINEL JAPONÊS



CARACTERÍSTICAS TÉCNICAS

- Cabeçal em alumínio extrudido, pintado na cor branca de 2, 3, 4 ou 5 vias com 14,5 mm de altura e larguras conforme pormenores a seguir.
- Perfil porta tela em alumínio extrudido e velcrado, pintado na cor branca com 30 mm de altura.
- Contrapesos em alumínio extrudido, pintado na cor branca, com as alturas de 25 mm ou 40 mm e com 3 mm de espessura.
- Sanefas em alumínio extrudido, pintado na cor branca ou anodizados na cor inox e prata com as alturas de 70 e 100 mm.

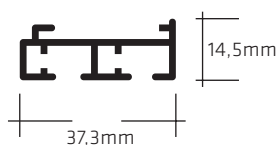
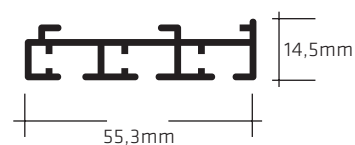
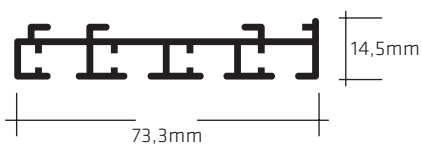
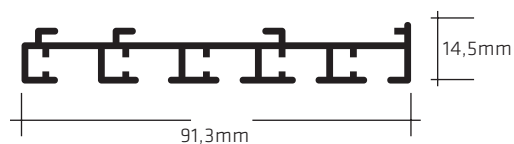
2 vias

3 vias

4 vias

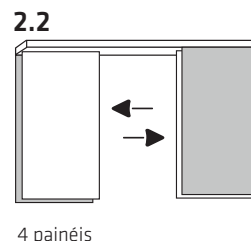
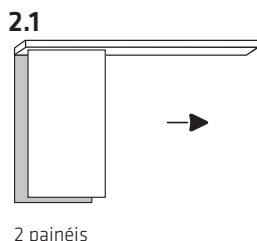
5 vias

TIPOS DE ABERTURAS E PAINÉIS

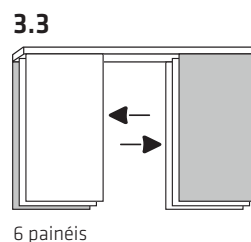
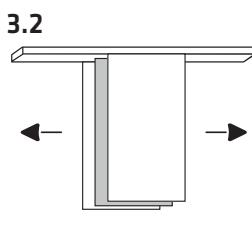
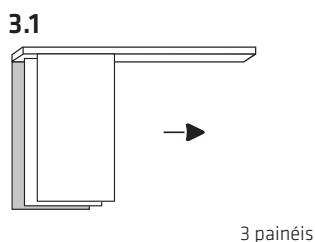
Cabeçal 2 vias



Cabeçal 3 vias



Cabeçal 4 vias

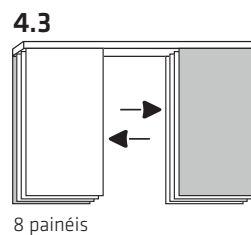
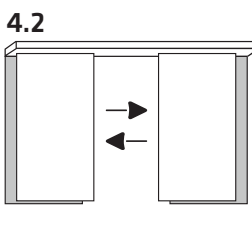
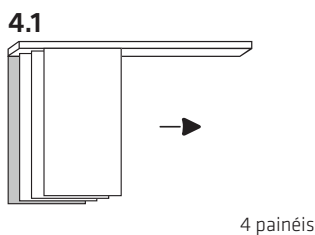

Cabeçal 5 vias

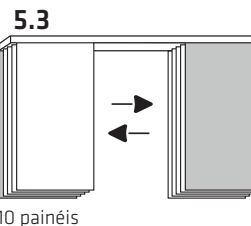
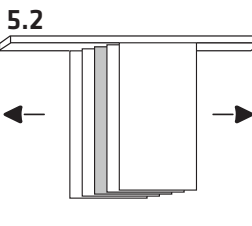
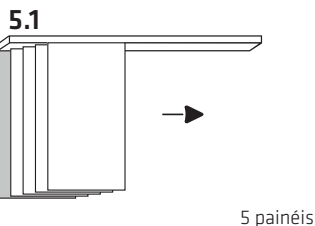

Se o accionamento for de cordão ou enlaçado, o painel sombreado será fixo. Sendo normal, poderá ser livre caso o cliente assim o pretenda. Não indicando no pedido será considerado com accionamento enlaçado.

TIPOS DE ACCIONAMENTO

A.C

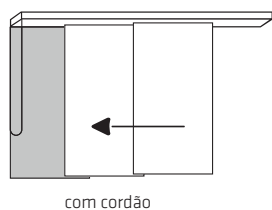

B.C

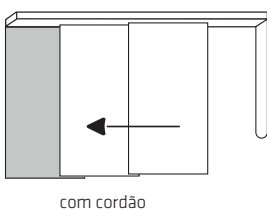

A.E

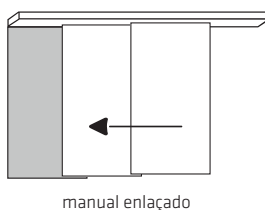

A.L

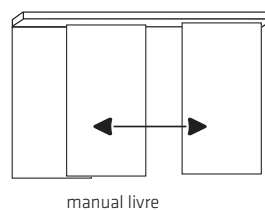

Nota: A sobreposição dos painéis (porta telas) é de 3 cm