

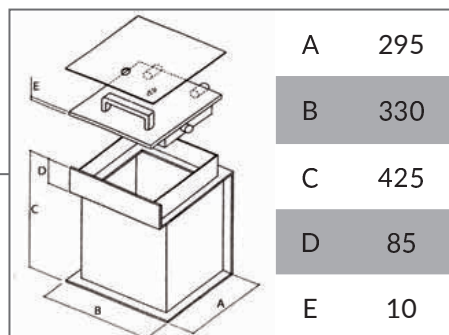







-  EN 1300  
**A**
-  10 mm
-  7016



Proteção ideal para a receita diária em pequenas e média empresas como por exemplo: supermercados, lojas, portas de gasolina, bem como todos os tipos de residência  
Proteção reforçada com uma placa em aço manganês



							
101.25.00.000	<b>P/01/C</b>	C	430 × 330 × 300	300 × 300 × 275	225 × 225	Kg 30	L 25