

Barras anti-pânico e puxadores



Dispositivos anti-pânico de empurrar

Serie Universal

A variedade de funções que apresenta esta série permite soluções para qualquer montagem, tanto em portas de uma folha como de duas folhas. Todos os modelos apresentam as seguintes características:

- » Muito fácil fácil reversibilidade.
- » Aplicações em portas corta-fogo.
- » Acionamento exterior mediante:
 - Puxador modular: utiliza um cilindro de perfil europeu de 30x10 mm que permite a sua utilização em qualquer espessura de porta.
 - Puxador Sena: utiliza um cilindro regulável para portas de 32 a 80 mm de espessura.
- » Suportes estreitos para perfis de pequenas dimensões.
- » Possibilidade de incorporar um micro interruptor.
- » Fácil de instalar graças a:
 - À regulação de 40 mm das caixas verticais.
 - À possibilidade de cortar a barra horizontal à medida de qualquer largura de porta.
- » Opcionalmente, está disponível a função PASO para os modelos 1910, 1930 e 1950. Esta função PASO não é válida para portas RF.



Suportes	Barra horizontal							
	P	V	B	N	C	I	LT	B
N		•	•	•	•	•		
S					•	•		
I							•	
P	•							
LT							•	
B								•

N: negro (RAL 9005)
 V: verde (RAL 6002)
 R: vermelho (RAL 3000)
 P: cinza (RAL 9006)
 B: branco (RAL 9010)

S: satinado (níquel mate)
 LT: latonado
 C: cromo
 I: inox (AISI304)



Suportes estreitos



Regulação



Reversível

Dispositivos anti-pânico de empurrar

Modelo sobrepor: 1910

Dispositivo de sobrepor com um ponto lateral de fecho. Trinco de aço basculante.

Acionamento exterior.

Certificação EN 1125:

3 7 6 B 1 3 2 2 A A

A embalagem inclui:

- × 1 suporte principal e outro secundário.
- × 1 barra horizontal oval de 900 mm.
- × 1 saco de acessórios quadra e parafusos.
- × Manual de instruções.



1910 acabamento inox

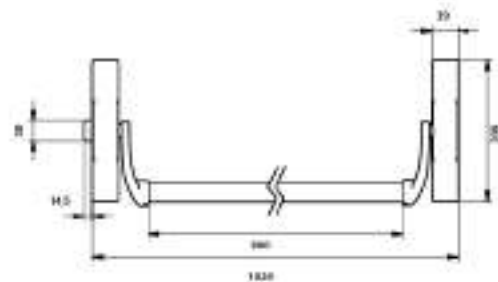

Porta de 1 folha



Porta de 2 folhas

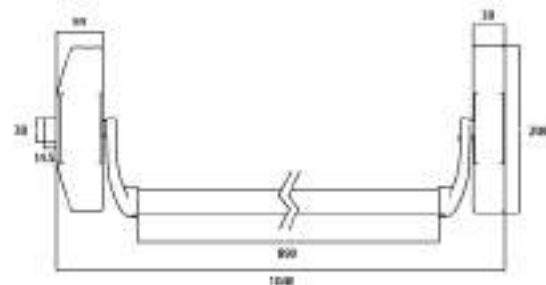

Dispositivos anti-pânico de empurrar

Modelo sobrepor: 1910

Dispositivo de sobrepor com um ponto lateral de fecho. Trinco de aço basculante.

Acionamento exterior.

Certificação EN 1125:

3 7 6 B 1 3 2 2 A A

A embalagem inclui:

- ✘ 1 suporte principal e outro secundário.
- ✘ 1 barra horizontal oval de 900 mm.
- ✘ 1 saco de acessórios quadra e parafusos.
- ✘ Manual de instruções.



1910 acabamento inox

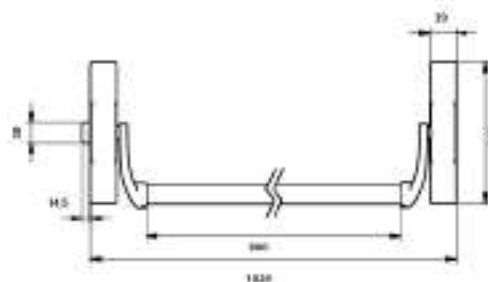

Porta de 1 folha



Porta de 2 folhas

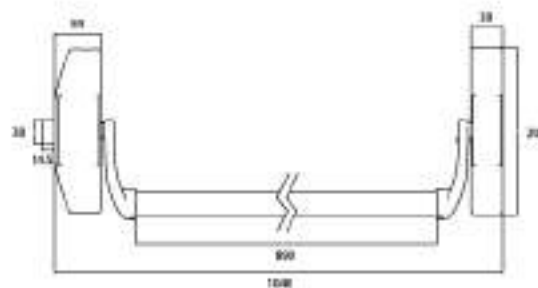

Dispositivos anti-pânico de empurrar

Modelo Sobrepor: 1930

Barra de sobrepor com dois pontos, alto e baixo, de fecho. Trinco de aço, basculante.

Altura standard: 2210 mm.

Acionamento exterior.

Certificação EN 1125:

3 7 6 B 1 3 2 2 A A

A embalagem inclui:

- » 1 suporte principal e outro secundário
- » 2 peças para os pontos de fecho alto e baixo.
- » 1 barra horizontal oval de 900 mm.
- » 2 varetas de 930 mm.
- » 1 saco de acessórios quadra e parafusos.
- » Manual de instruções.

Configuração

Porta de 1 folha

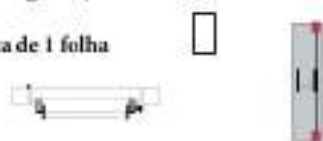

Porta de 2 folhas



1930 acabamento acetinado inox.

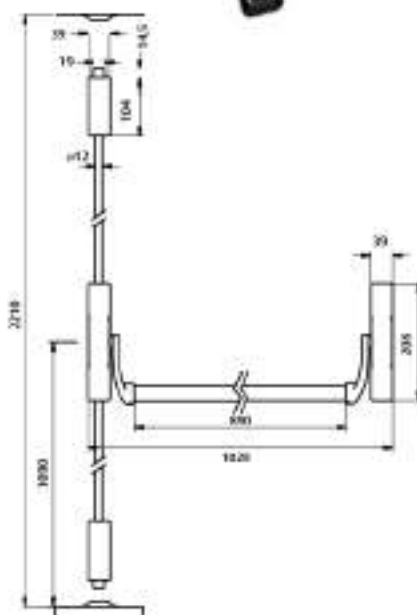

Dispositivos anti-pânico de empurrar

Modelo de embutir de 1 folha

Certificado EN 1125 dos dois conjuntos 1970 + CF60, 1970 + 2035T/4039T/ 2037F y 19709G9 + 2230PA / 2240BA.

3 7 6 B|0* 1 3 2 2 A A/B**

* B: APTO para instalação em portas corta-fogo CF60 - 2035T - 2037F - 4039T

* Q: NÃO APTO para instalação em portas corta-fogo 2240BA - 2230PA

** A: CF60 - 2035T - 2037F - 4039T

** B: 2240BA - 2230PA

1. Barra anti-pânico

A embalagem inclui:

- » 1 barra horizontal oval de 900 mm.
- » 1 suporte principal e 1 suporte auxiliar.
- » 1 placa interior Ref. E1971INNE para colocar unicamente com fechaduras da série CF60.
- » Manual de instruções.
- » 1 saco de acessórios:
 - Parafusos
 - Embelezador de plástico (para colocar com a placa interior)



3. Aacionamento exterior

Dependendo do tipo de fechadura há que seleccionar o modelo de aacionamento exterior. Disponimos das opções válidas para a fechadura CF60 e outra para as fechaduras 2035T, 2037F, 4039T, 2230BA e 2240PA.

2. Fechaduras

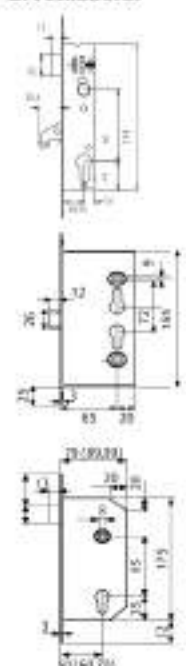

2240BA. 1 ponto, quadra de 8. Indicar o sentido.

2230PA. Multipontos, quadra de 8. Indicar o sentido. Solução válida para portas de 1 folha.

CF60. Quadra de 9. Reversível.

2035T. Quadra de 8. Indicar sentido. Sem cilindro, para portas de passagem.

2037F. Quadra de 8. Reversível.

4039T. Quadra de 8. Indicar sentido.

Modelo	barra	Quadra mm	Acabamento suportes	Acabamento barra
1970	900	9	Negro	Verde
1970	900	9	Negro	Negro
1970	900	9	Negro	Rojo

Acionamentos exteriores para série Universal

Acionamento exterior de sobrepor

Puxador Sena

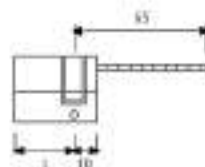

Quadra de 8 mm Cilindro regulável em qualquer sistema

Escudo cego

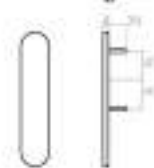

E1910EX

Chave

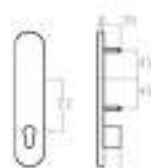

E1911EX

Muleta + chave

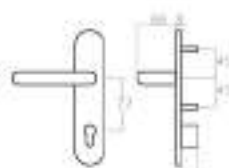

S1912EX

Muleta

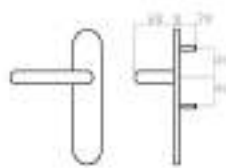

S1913EX

Puxador fixo



TTF10U

Puxador Modular



Quadra de 8 mm Cilindro 30 x 10 de r=15 mm em qualquer sistema

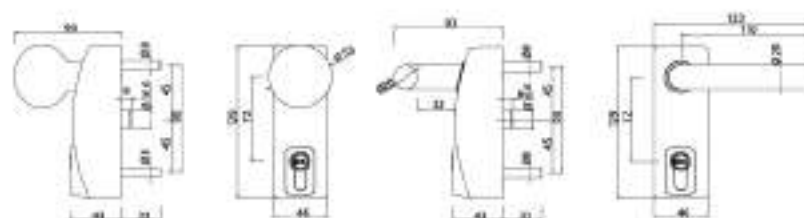

Acionamentos exteriores para série Universal

Acionamento exterior de embutir

Para fechaduras da série CF60



Quadra de 8 mm

Escudo cego

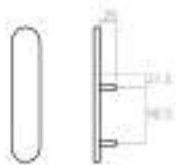

EDF90EX

Chave

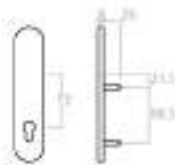

EDF91EX

Muleta + chave

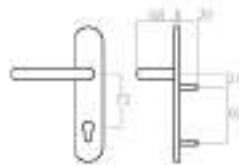

SDF92EX

Muleta

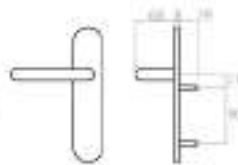

SDF93EX

Puxador fixo

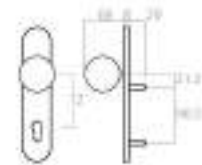

TTF72U

Para fechaduras das séries 2035T, 2037F, 4039T, 2230BA e 2240PA



Quadra de 8 mm

Escudo cego

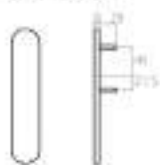

EDF30EX

Chave



EDF31EX

Muleta + chave

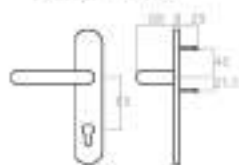

SDF32EX

Muleta

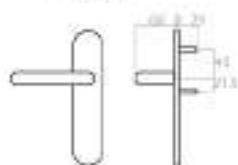

SDF33EX

Puxador fixo

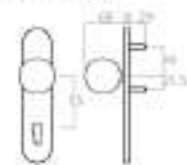

TTF85U

Dispositivos anti-pânico de deslizamento

Modelo de sobrepor. TOP15

Dispositivo de sobrepor com um ponto lateral de fecho. Trinco de aço, orbital.

Acionamento exterior.

Certificação EN 1125:

3 7 6 B 1 4 2 2 B A

A embalagem inclui:

- » 1 barra horizontal + sistema modular.
- » 1 saco de acessórios com chapa testa, quadra, parafusos.
- » Manual instruções.



DEC
Disabled,
Elderly and
Children



TOP15 acabamento inox.

2 millones
de ciclos
CERTIFICADO AENOR

Configuração

Porta de 1 folha

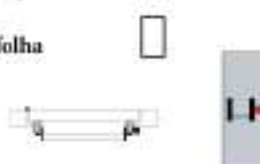

Porta de 2 folhas

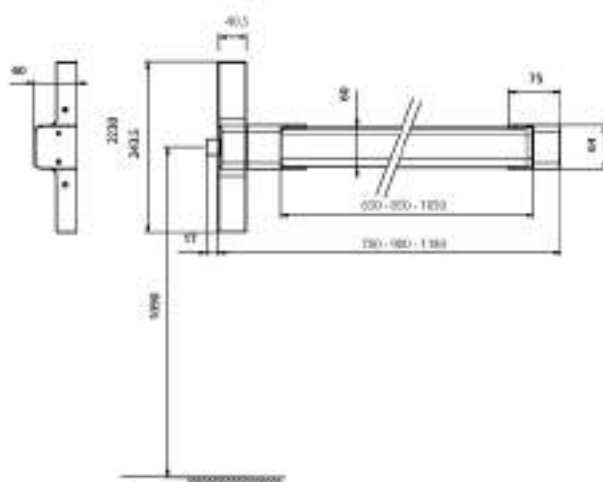
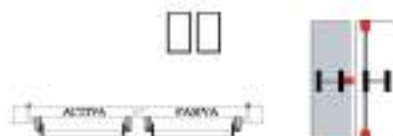

Dispositivos anti-pânico de deslizamento

Modelo de sobrepor. TOP15

Dispositivo de sobrepor com um ponto lateral de fecho. Trinco de aço, orbital.

Acionamento exterior.

Certificação EN 1125:

3 7 6 B 1 4 2 2 B A

A embalagem inclui:

- » 1 barra horizontal + sistema modular.
- » 1 saco de acessórios com chapa testa, quadra, parafusos.
- » Manual instruções.



DEC
Disabled,
Elderly and
Children



TOP15 acabamento inox.

2 millones
de ciclos
CERTIFICADO AENOR

Configuração

Porta de 1 folha



Porta de 2 folhas

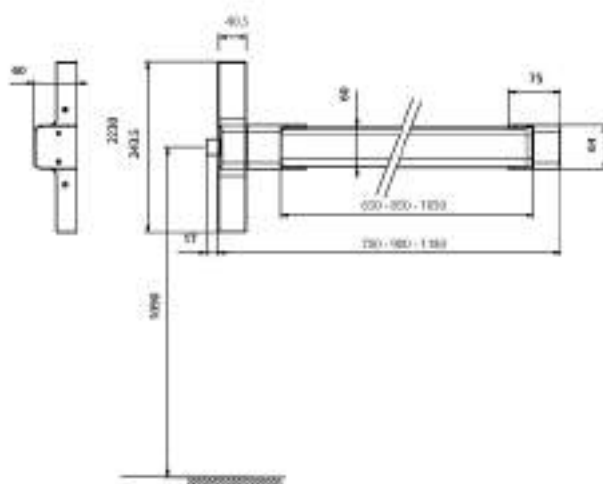
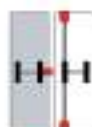

Dispositivos anti-pânico de deslizamento

Modelo de sobrepor. TOP35

Dispositivo de sobrepor com dois/três pontos de fecho. Trinco em aço, orbital.

Acionamento exterior.

Certificação EN1125:

3 7 6 B 1 4 2 2 B A

A embalagem inclui:

- 1 barra horizontal + sistema modular.
- 2 sacos de acessórios com chapas testa, trinco (central, alto e baixo), quadra, parafusos.
- Manual de instruções



2 millones de ciclos
CERTIFICADO AENOR

Configuração

Porta de 1 folha



Porta de 2 folhas

